



## Classification and Characteristics of Rolling Bearings

### 1.1 Rolling bearing construction

Most rolling bearings consist of rings with raceway (inner ring and outer ring), rolling elements (either balls or rollers) and cage. The cage separates the rolling elements at regular intervals, holds them in place within the inner and outer raceways, and allows them to rotate freely.

### Raceway (inner ring and outer ring) or raceway washer 1)

The surface on which rolling elements roll is called the “raceway surface”. The load placed on the bearing is supported by this contact surface. Generally the inner ring fits on the axle or shaft and the outer ring on the housing. Note 1: The raceway of thrust bearing is called “raceway washer,” the inner ring is called the “shaft raceway washer” and the outer ring is called the “housing raceway washer.”

### Rolling elements

Rolling elements classify in two types: balls and rollers. Rollers come in four types: cylindrical, needle, tapered, and spherical. Balls geometrically contact with the raceway surfaces of the inner and outer rings at “points”, while the contact surface of rollers is a “line” contact. Theoretically, rolling bearings are so constructed as to allow the rolling elements to rotate orbitally while also rotating on their own axes at the same time. Cages function to maintain rolling elements at a uniform pitch so load is never applied directly to the cage and to prevent the rolling elements from falling out when handling the bearing. Types of cages differ according to way they are manufactured, and include pressed, machined and formed cages.

### 1.2 Classification of rolling bearings

Rolling bearings divide into two main classifications: ball bearings and roller bearings. Ball bearings are classified according to their bearing ring configurations: deep groove type and angular contact type. Roller bearings on the other hand are classified according to the shape of the rollers: cylindrical, needle, tapered and spherical. Rolling bearings can be further classified according to the direction in which the load is applied; radial bearings carry radial loads and thrust bearings carry axial loads.

Other classification methods include: 1) number of rolling rows (single, double, or 4-row), 2) separable and non-separable, in which either the inner ring or the outer ring can be detached. There are also bearings designed for special applications, such as: railway car journal roller bearings, ball screw support bearings, turntable bearings, as well as linear motion bearings (linear ball bearings, linear roller bearings and linear flat roller bearings). Types of rolling bearings are given in Fig. 1.2.

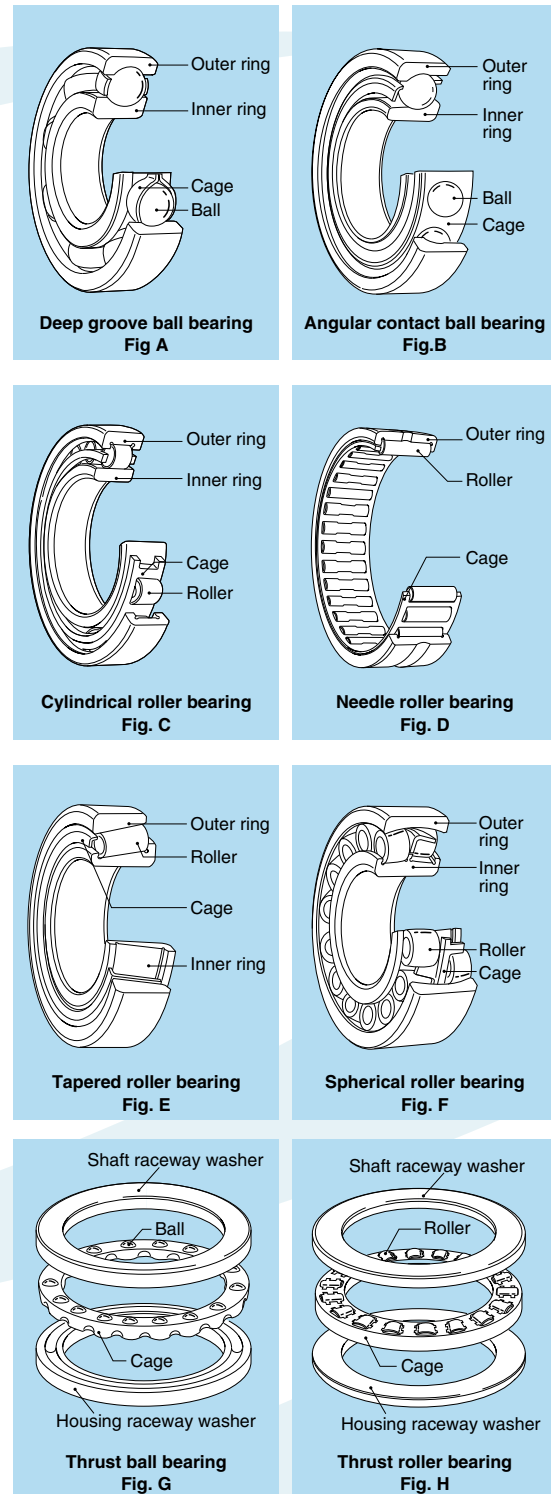

Fig. 1.1 Rolling bearing

### 1.3 Characteristics of rolling bearings

#### 1.3.1 Characteristics of rolling bearings

Rolling bearings come in many shapes and varieties, each with its own distinctive features. However, when compared with sliding bearings, rolling bearings all have the following advantages:

- (1) The starting friction coefficient is lower and there is little difference between this and the dynamic friction coefficient.
- (2) They are internationally standardized, interchangeable and readily obtainable.
- (3) They are easy to lubricate and consume less lubricant.
- (4) As a general rule, one bearing can carry both radial and axial loads at the same time.
- (5) May be used in either high or low temperature applications.
- (6) Bearing rigidity can be improved by preloading.

Construction, classes, and special features of rolling bearings are fully described in the boundary dimensions and bearing numbering system section.

#### 1.3.2 Ball bearings and roller bearings

Table 1.1 gives a comparison of ball bearings and roller bearings.

**Table 1.1 Comparison of ball bearings and roller bearings**

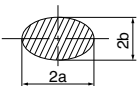
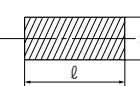
	Ball bearings	Roller bearings
Contact with raceway	 <p><b>Point contact</b> Contact surface is oval when load is applied.</p>	 <p><b>Linear contact</b> Contact surface is generally rectangular when load is applied.</p>
Characteristics	Because of point contact there is little rolling resistance, ball bearings are suitable for low torque and high-speed applications. They also have superior acoustic characteristics.	Because of linear contact, rotational torque is higher for roller bearings than for ball bearings, but rigidity is also higher.
Load capacity	Load capacity is lower for ball bearings, but radial bearings are capable of bearing loads in both the radial and axial direction.	Load capacity is higher for rolling bearings. Cylindrical roller bearings equipped with a lip can bear slight radial loads. Combining tapered roller bearings in pairs enables the bearings to bear an axial load in both directions.

#### 1.3.3 Radial and thrust bearings

Almost all types of rolling bearings can carry both radial and axial loads at the same time.

Generally, bearings with a contact angle of less than 45° have a much greater radial load capacity and are classed as radial bearings; whereas bearings which have a contact angle over 45° have a greater axial load capacity and are classed as thrust bearings. There are also bearings classed as complex bearings which combine the loading characteristics of both radial and thrust bearings.

#### 1.3.4 Standard bearings and special bearings

The boundary dimensions and shapes of bearings conforming to international standards are interchangeable and can be obtained easily and economically over the world over. It is therefore better to design mechanical equipment to use standard bearings.

However, depending on the type of machine they are to be used in, and the expected application and function, a non-standard or specially designed bearing may be best to use. Bearings that are adapted to specific applications, and “unit bearings” which are integrated (built-in) into a machine’s components, and other specially designed bearings are also available. The feature of typical standard bearings are as follows:

#### Deep groove ball bearings

The most common type of bearing, deep groove ball bearings are widely used in a variety of fields. Deep groove ball bearings include shield bearings and sealed bearings with grease make them easier to use. Deep groove ball bearings also include bearings with a locating snap-ring to facilitate positioning when mounting the outer ring, expansion compensating bearings which absorb dimension variation of the bearing fitting surface due to housing temperature, and TAB bearings that are able to withstand contamination in the lubricating oil.

**Table 1.2 Configuration of sealed ball bearings**

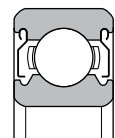
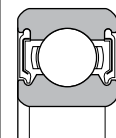
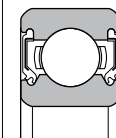
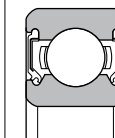
Type and symbol	Shield	Sealed		
	Non-contact ZZ	Non-contact LLB	Contact LLU	Low torque LLH
Configuration				

### Angular contact ball bearings

The line that unites point of contact of the inner ring, ball and outer ring runs at a certain angle (contact angle) in the radial direction. Bearings are generally designed with three contact angles. Angular contact ball bearings can support an axial load, but cannot be used by single bearing because of the contact angle. They must instead be used in pairs or in combinations. Angular contact ball bearings include double row angular contact ball bearings for which the inner and outer rings are combined as a single unit. The contact angle of double row angular contact ball bearings is 25°. There are also four-point contact bearings that can support an axial load in both directions by themselves. These bearings however require caution because problems such as excessive temperature rise and wearing could occur depending on the load conditions.

**Table 1.3 Contact angle and symbol**

Contact angle and contact angle symbol		15°	30°	40°
Contact angle symbol		C	A <sup>1)</sup>	B

Note 1: Contact angle symbol has been abbreviated as "A".

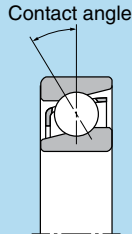

**Table 1.4 Configuration of double row angular contact ball bearings**

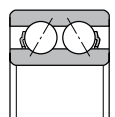
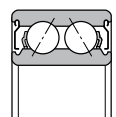
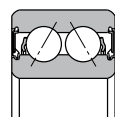
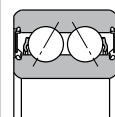
Type and symbol	Open	Shield ZZ	Non-contact sealed LLM	Contact sealed LLD
Configuration				

**Table 1.5 Combinations of duplex angular contact ball bearings**

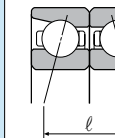
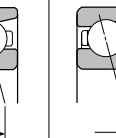
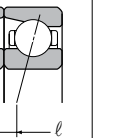
Type and symbol	Back-to-back duplex DB	Face-to-face duplex DF	Tandem duplex DT
Configuration			

### Cylindrical roller bearings

Uses rollers for rolling elements, and therefore has a high load capacity. The rollers are guided by the ribs of the inner or outer ring. The inner and outer rings can be separated to facilitate assembly, and both can be fit with shaft or housing tightly. If there is no ribs, either the inner or the outer ring can move freely in the axial direction. Cylindrical roller bearings are therefore ideal to be used as so-called "free side bearings" that absorb shaft expansion. In the case where there is a ribs, the bearing can bear a slight axial load between the end of the rollers and the ribs. Cylindrical roller bearings include the HT type which modifies the shape of roller end face and ribs for increasing axial load capacity. And the E type with a special internal design for enhancing radial load capacity. The E type is standardized for small-diameter sizes. Table 1.6 shows the basic configuration for cylindrical roller bearings.

In addition to these, there are cylindrical roller bearings with multiple rows of rollers and the SL type of full complement roller bearing without cage.

**Table 1.6 Types of cylindrical roller bearings**

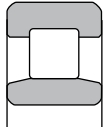
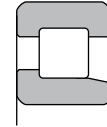
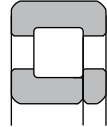
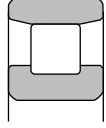
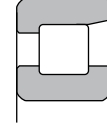
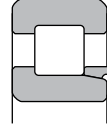
Type and Symbol	NU type N type	NJ type NF type	NUP type NH type (NJ+HJ)
Drawings	 NU type	 NJ type	 NUP type
	 N type	 NF type	 NH type

**Tapered roller bearings**

Tapered roller bearings are designed so the inner/outer ring raceway and apex of the tapered rollers intersect at one point on the bearing centerline. By receiving combined load from inner and outer ring, the rollers are pushed against the inner ring rib and roll guided with rib. Induced force is produced in the axial direction when a radial load is applied, so must be handled by using a pair of bearings. The inner ring with rollers and outer ring come apart, thus facilitating mounting with clearance or preload. Assembled clearance is however hard to manage and requires special attention. Tapered roller bearings are capable of supporting large loads in both the axial and radial directions.

NTN bearings with 4T-, ET-, T- and U attached to the name conform to ISO and JIS standards for sub-unit dimensions (nominal contact angle, nominal small end diameter of outer ring) and are internationally interchangeable.

NTN also has a line of case hardened steel bearings designed for longer life (ETA-, ET-, etc.). NTN tapered roller bearings also include bearings with two and four rows of tapered rollers for extra-heavy loads.

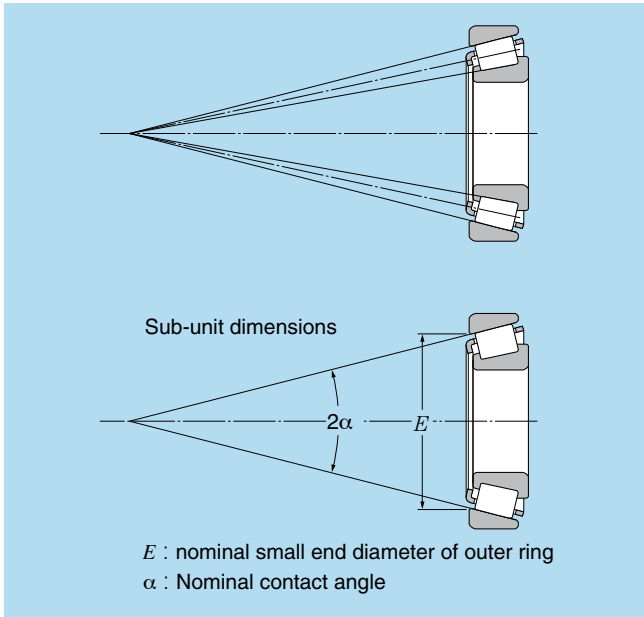

**Fig. 1.3 Tapered roller bearings**

**Spherical roller bearings**

Equipped with an outer ring with a spherical raceway surface and an inner ring which holds two rows of barrelshaped rolling elements, NTN spherical roller bearings are able to adjust center alignment to handle inclination of the axle or shaft. There are variety of bearing types that differ according to internal design. Spherical roller bearings include as type equipped with

an inner ring with a tapered bore. The bearing can easily be mounted on a shaft by means of an adapter or withdrawal sleeve. The bearing is capable of supporting heavy loads, and is therefore often used in industrial machinery. When heavy axial load is applied to the bearing, the load on rollers of another row is disappeared, and can cause problems. Attention must therefore be paid to operating conditions.

**Table 1.7 Types of spherical roller bearings**

Type	Standard (B type)	C type	213 type	E type
Configuration				

**Thrust bearings**

There are many types of thrust bearings that differ according to shape of rolling element and application. Allowable rotational speed is generally low and special attention must be paid to lubrication. In addition to the ones given below, there are various types of thrust bearings for special applications. For details, see the catalog devoted to the concerned type of bearing.

**Table 1.8 Types of thrust bearings**

Type	Single direction thrust ball bearing	Needle roller thrust bearing
Configuration		
	<b>Cylindrical roller thrust bearing</b>	<b>Spherical roller thrust bearing</b>
		<p>Center alignment angle</p>

**Needle roller bearings**

Needle roller bearings use needle rollers as rolling elements. The needle rollers are a maximum of 5 mm in diameter and are 3 to 10 times as long as they are in diameter. Because the bearings use needle rollers as rolling elements, the cross-section is thin, but they have a high load capacity for their size. Because of the large number of rolling elements, the bearings have high rigidity and are ideally suited to wobbling or pivoting motion.

There is a profusion of types of needle roller bearings, and just a few of the most representative types are covered here. For details, see the catalog devoted to the concerned type of bearing.

**Bearing unit**

A unit comprised of a ball bearing inserted into various types of housings. The housing can be bolted onto machinery and the inner ring can be easily mounted on the shaft with a set screw. This means the bearing unit can support rotating equipment without special design to allow for mounting. A variety of standardized housing shapes is available, including pillow and flange types. The outer diameter of the bearing is spherical just like the inner diameter of the housing, so it capable of aligning itself on the shaft. For lubrication, grease is sealed inside the bearing, and particle generation is prevented by a double seal. For details, see the catalog devoted to the concerned type of bearing.

**Table 1.9 Main types of needle roller bearings**

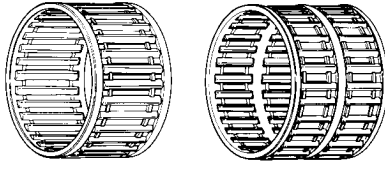
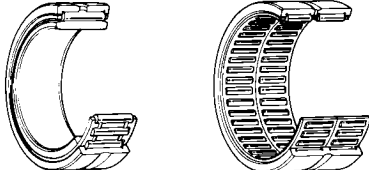
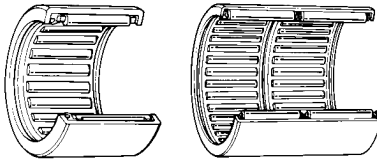
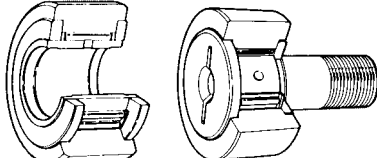
Type	Needle roller bearing with cage
Configuration	
	Solid type needle roller bearings
	
	Shell type needle roller bearings
	
Roller follower Cam follower	
	

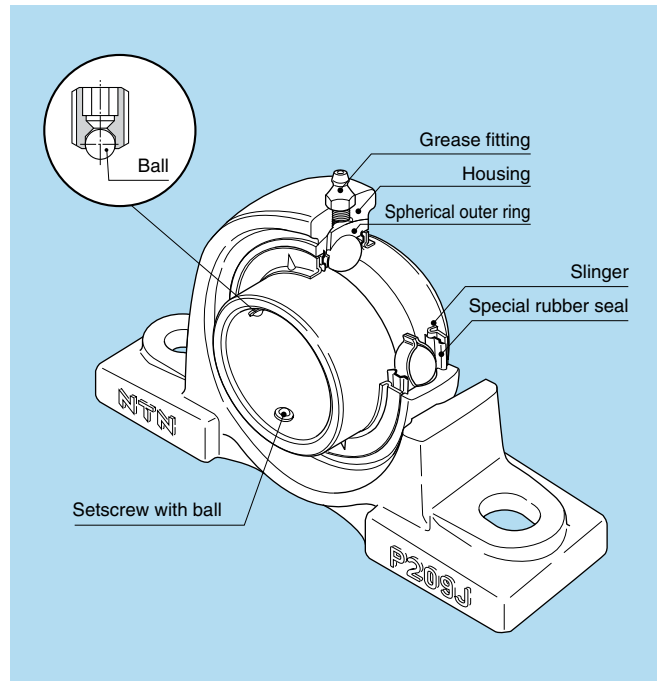

**Fig. 1.4 Oil-lubricated bearing unit**

## Bearing Internal Clearance and Preload

### Bearing internal clearance

Bearing internal clearance is the amount of internal free movement before mounting.

As shown in Fig. 8.1, when either the inner ring or the outer ring is fixed and the other ring is free to move, displacement can take place in either an axial or radial direction. This amount of displacement (radially or axially) is termed the internal clearance and, depending on the direction, is called the radial internal clearance or the axial internal clearance.

When the internal clearance of a bearing is measured, a slight measurement load is applied to the raceway so the internal clearance may be measured accurately. However, at this time, a slight amount of elastic deformation of the bearing occurs under the measurement load, and the clearance measurement value (measured clearance) is slightly larger than the true clearance. This difference between the true bearing clearance and the increased amount due to the elastic deformation must be compensated for. These compensation values are given in Table 8.1. For roller bearings the amount of elastic deformation can be ignored.

The internal clearance values for each bearing class are shown in Tables 8.3 through 8.11.

### Internal clearance selection

The internal clearance of a bearing under operating conditions (effective clearance) is usually smaller than the same bearing's initial clearance before being installed and operated. This is due to several factors including bearing fit, the difference in temperature between the inner and outer rings, etc. As a bearing's operating clearance has an effect on bearing life, heat generation, vibration, noise, etc.; care must be taken in selecting the most suitable operating clearance.

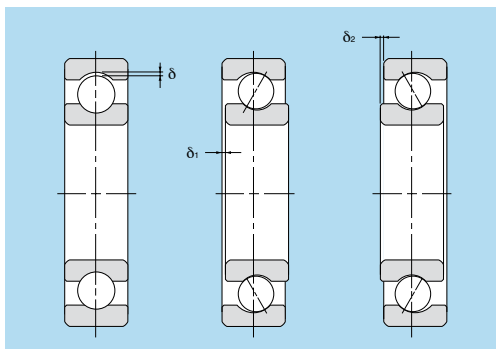

Radial clearance =  $\delta$  Axial clearance =  $\delta_1 + \delta_2$

Fig. 8.1 Internal clearance

### Criteria for selecting bearing internal clearance

A bearing's life is theoretically maximum when operating clearance is slightly negative at steady operation. In reality it is however difficult to constantly maintain this optimal condition. If the negative clearance becomes enlarged by fluctuating operating conditions, heat will be produced and life will decrease dramatically. Under ordinary circumstances you should therefore select an initial internal clearance where the operating clearance is slightly larger than zero. For ordinary operating conditions, use fitting for ordinary loads. If rotational speed and operating temperature are ordinary, selecting normal clearance enables you to obtain the proper operating clearance. Table 8.2 gives examples applying internal clearances other than CN (normal) clearance.

### Calculation of operating clearance

Operating clearance of a bearing can be calculated from initial bearing internal clearance and decrease in internal clearance due to interference and decrease in internal clearance due to difference in temperature of the inner and outer rings.

$$\delta_{\text{eff}} = \delta_o - (\delta_f + \delta_t) \dots\dots\dots (8.1)$$

where,

$\delta_{\text{eff}}$  : Effective internal clearance, mm

$\delta_o$  : Bearing internal clearance, mm

$\delta_f$  : Reduced amount of clearance due to

Table 8.1 Adjustment of radial internal clearance based on measured load (deep groove ball bearing) Unit  $\mu\text{m}$

Nominal Bore Diameter <i>d</i> mm	Measuring Load N (kgf)	Internal clearance adjustment				
		C2	CN	C3	C4	C5
10 <sup>●</sup>	18	24.5 (2.5)	3~4	4	4	4
18	50	49 (5)	4~5	5	6	6
50	200	147 (15)	6~8	8	9	9

● This diameter is included in the group.

Table 8.2 Examples of applications where bearing clearances other than CN (normal) clearance are used

Operating conditions	Applications	Selected clearance
With heavy or shock load, clearance is large.	Railway vehicle axles	C3
	Vibration screens	C3, C4
With indeterminate load, both inner and outer rings are tight-fitted.	Railway vehicle traction motors	C4
	Tractors and final speed regulators	C4
Shaft or inner ring is heated.	Paper making machines and driers	C3, C4
	Rolling mill table rollers	C3
Reduction of noise and vibration when rotating.	Micromotors	C2, CM
Adjustment of clearance to minimize shaft runout.	Main spindles of lathes (Double-row cylindrical roller bearings)	C9NA, C9NA
Loose fitting for both inner and outer rings.	Compressor roll neck	C2

Courtesy of NTN Bearing

# Bearing Failure and Analysis

Rolling bearings are precision machine elements found in a wide variety of applications. They are typically reliable even under the toughest conditions. Under normal operating conditions, bearings have a substantial service life, which is expressed as either a period of time or as the total number of rotations before the rolling elements or inner and outer ring fatigue or fail. Less than 1 percent (0.35 percent specifically— see Figure 1) of rolling bearings do not reach their expected life. (Source: FAG Bearing Antriebstechnik 18 from 1979.)

## Premature Bearing Failure

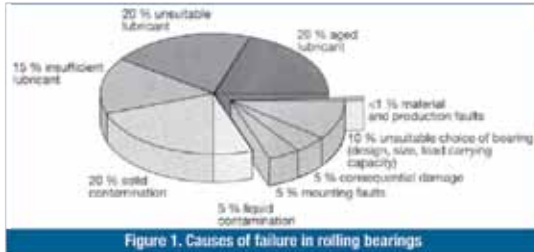

Figure 1. Causes of failure in rolling bearings

When a bearing does fail prematurely, it is usually due to causes that could have been avoided. For this reason, the possibility of reaching conclusions about the cause of a defect by means of studying its appearance is useful. It is most important to correct the causes and prevent future failures and the costs that follow. Most bearing failures such as flaking and pitting, spalling, unusual wear patterns, rust and corrosion, creeping, skewing and others are usually attributed to a relatively small group of causes that are often interrelated and correctable. These causes include lubrication, mounting, operational stress and bearing selection and environmental influence.

## Proper/Improper Lubrication and “Grease Service Life”

The purpose of lubricating the bearing is to cover the rolling and sliding contact surfaces with a thin oil film to avoid direct metal to metal contact. When done effectively it:

1. Reduces friction and abrasion
2. Transports heat generated by friction
3. Prolongs service life
4. Prevents rust and corrosion
5. Excludes foreign objects and contamination from rolling elements

Grease is generally used for lubricating bearings because it is easy to handle and simplifies the sealing system, while oil lubrication is generally suitable for high speed or high temperature operations.

Generally lubrication failures occur due to:

1. The wrong lubricant type
2. Too little grease/oil
3. Too much grease/oil
4. Mixing of grease/oil
5. Contamination of the grease/oil by objects or water

In addition to considering normal bearing service life, normal grease service life is important to consider since together they maximize bearing life. Grease service life is the time during which proper bearing function is sustained by a particular quantity and category of grease. This is especially critical in pump, compressor, motor and super precision applications.

## Mounting and Installation of Bearings

It is critical in the mounting and installation process to pay strict attention to:

1. Use of proper tools and ovens/induction heaters. Use a sleeve to impact the entire inner ring face of the ring that is being press fit.
2. Verify the shaft and housing tolerances. If the fit is too tight, too much preload is created. If the fit is too loose, too little resulting preload may allow the shaft to rotate or creep in the bearing. Check for proper diameters, roundness and chamfer radius.
3. Avoid misalignment or shaft deflection. This is especially critical in mounting bearings that have separable components such as cylindrical roller bearings where successful load bearing and optimal life are established or diminished at installation.
4. Be aware of radial internal clearance (see Figure 2). It is critical to maintain the proper RIC established in the original design. The standard scale in order of ascending clearance is C2, C0, C3, C4, C5. The proper clearance for the application is critical in that it allows for the challenges of:

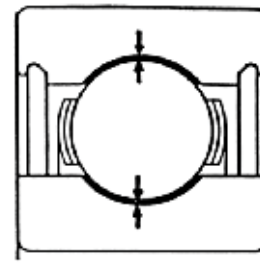

Figure 2. Radial internal clearance.

- Lubrication. A proper film of lubricant must be established between the rolling elements. Reducing internal clearance and impeding lubricant flow can lead to premature failure.
- Shaft fit. A reduction in the radial internal clearance is inevitable when the bearing is press fit.
- Heat. In normal bearing operation, heat is produced that creates thermal expansion of the inner and outer rings. This can reduce the internal clearance, which will reduce the optimal bearing life.

### **Operational Stress and Bearing Selection**

It is generally the exception to find a bearing that has been improperly designed into an application. However, factors within the larger application may change. If loads become too high, overloading and early fatigue may follow. If they are too low, skidding and improper loading of the rolling elements occur. Early failure will follow in each situation. Similar issues arise with improper internal clearance. The first sign of these issues will be unusual noises and/or increased temperatures.

- Increased temperature. Bearing temperature generally rises with start-up and stabilizes at a temperature slightly lower than at start-up (normally 10 to 40 deg C higher than room temperature). A desirable bearing temperature is below 100 deg C.

- Noises. Abnormal bearing sounds typically indicate certain issues in the bearing application. While this is a subjective test, it is helpful to know that a screech or howl sound generally indicates too large an internal clearance or poor lubrication on a cylindrical roller bearing while a crunching felt when the shaft is rotated by hand usually indicates contamination of the raceways. See [www.pump-zone.com](http://www.pump-zone.com) for a table of abnormal bearing sounds.

Operational stresses in the applications can impact bearing life as well. It is critical to isolate vibrations in associated equipment as they can cause uneven running and unusual noises.

### **Environmental Influence**

Even with the best design, lubrication and installation failures will occur if the operating environment is not considered.

While many potential issues exist, the primary ones are:

1. Dust and dirt that can aggressively contaminate a bearing. Great care should be given to use proper sealing techniques.

2. Aggressive media or water. Once again, sealing is primary. The use of specialty type seals is recommended such as pump mechanical or labyrinth style seals that do not score the shaft.

3. External heat. The ambient operating temperature mandates many choices in radial internal clearance, high temperature lubricants, intermittent or continuous running and others that affect bearing life.

4. Current passage or electrolytic corrosion. If current is allowed to flow through the rolling elements, sparks can create pitting or fluting on the bearing surfaces. This should be corrected by creating a bypass circuit for the current or through the use of insulation on or within the bearing. This should be an inherent design consideration in applications such as wind turbines and all power generating equipment.

In conclusion, the first step in the overall prevention of bearing failure lies in the consideration of bearing technologies most suitable to the application with regard to specifications, recommendations, maintenance strategies, fatigue life and wear resistance of the bearing in relation to the application. That being said, premature bearing failure within a proper application is typically attributed to one or more of the causes discussed (lubrication, mounting, operational stress and bearing selection or environmental influence) and can and should be corrected to avoid future bearing failures and additional cost.

### **P&S**

#### *Sources*

- Barden Corporation. Machine Tool Technical Bulletin for Engineering and Lubrication. 2010.
  - FAG Bearings Corp. Rolling Bearing Damage. Publ. No. WL 82 102/2 December 1997.
  - Fersa Bearings. Roller Bearings: Failure Diagnosis. 2009.
  - Koyo Bearing Corp. Rolling Bearings: Failures, Causes and Countermeasures. Catalog No. 322E. December 1995.
  - NTN Bearing Corp. Products and Technology. Care and Maintenance of Bearings. 2009.
- Figure 2. Radial internal clearance.



## Bearing Damage and Corrective Measures

If handled correctly, bearings can generally be used for a long time before reaching their fatigue life. If damage occurs prematurely, the problem could stem from improper bearing selection, handling or lubrication. In this occurs, take note of the type of machine on which the bearings is used, the place where it is mounted, service conditions and surrounding structure. By investigating several possible causes surmised from the type of damage and condition at the time the damage occurred, it is possible to prevent the same kind of damage from reoccurring. Table 16.1 gives the main causes of bearing damage and remedies for correcting the problem.

**Table 16.1 Bearing damage, main causes of bearing damage and remedies for correcting the problem**

Description		
<b>Flaking</b>  Surface of the raceway and rolling elements peels away in flakes Conspicuous hills and valleys form soon afterward.		<b>Causes</b> <ul style="list-style-type: none"> <li>• Excessive load, fatigue life, improper handling</li> <li>• Improper mounting.</li> <li>• Improper precision in the shaft or housing.</li> <li>• Insufficient clearance.</li> <li>• Contamination.</li> <li>• Rust.</li> <li>• Improper lubrication</li> <li>• Drop in hardness due to abnormally high temperatures.</li> </ul>
		<b>Correction</b> <ul style="list-style-type: none"> <li>• Select a different type of bearing.</li> <li>• Reevaluate the clearance.</li> <li>• Improve the precision of the shaft and housing.</li> <li>• Review application conditions.</li> <li>• Improve assembly method and handling.</li> <li>• Reevaluate the layout (design) of the area around the bearing.</li> <li>• Review lubricant type and lubrication methods.</li> </ul>
<b>Seizure</b>  The bearing heats up and becomes discolored. Eventually the bearing will seize up.		<b>Causes</b> <ul style="list-style-type: none"> <li>• Insufficient clearance (including clearances made smaller by local deformation).</li> <li>• Insufficient lubrication or improper lubricant.</li> <li>• Excessive loads (excessive preload).</li> <li>• Skewed rollers.</li> <li>• Reduction in hardness due to abnormal temperature rise</li> </ul>
		<b>Correction</b> <ul style="list-style-type: none"> <li>• Review lubricant type and quantity.</li> <li>• Check for proper clearance. (Increase clearances.)</li> <li>• Take steps to prevent misalignment.</li> <li>• Review application conditions.</li> <li>• Improve assembly method and handling.</li> </ul>
<b>Cracking and notching</b>  Localized flaking occurs. Little cracks or notches appear.		<b>Causes</b> <ul style="list-style-type: none"> <li>• Excessive shock loads.</li> <li>• Improper handling (use of steel hammer, cutting by large particles of foreign matter)</li> <li>• Formation of decomposed surface layer due to improper lubrication</li> <li>• Excessive interference.</li> <li>• Large flaking.</li> <li>• Friction cracking.</li> <li>• Imprecision of mounting mate (oversized fillet radius)</li> </ul>
		<b>Correction</b> <ul style="list-style-type: none"> <li>• Review lubricant (friction crack prevention).</li> <li>• Select proper interference and review materials.</li> <li>• Review service conditions.</li> <li>• Improve assembly procedures and take more care in handling.</li> </ul>



**Table 16.1 Bearing damage, main causes of bearing damage and remedies for correcting the problem**

Description		
<b>Cage damage</b> Rivets break or become loose resulting in cage damage.		<b>Causes</b> <ul style="list-style-type: none"> <li>Excessive moment loading.</li> <li>High speed or excessive speed fluctuations.</li> <li>Inadequate lubrication.</li> <li>Impact with foreign objects.</li> <li>Excessive vibration.</li> <li>Improper mounting. (Mounted misaligned)</li> </ul>
		<b>Correction</b> <ul style="list-style-type: none"> <li>Reevaluation of lubrication conditions.</li> <li>Review of cage type selection.</li> <li>Investigate shaft and housing rigidity.</li> <li>Review service conditions.</li> <li>Improve assembly method and handling.</li> </ul>
<b>Rolling path skewing</b> Abrasion or an irregular, rolling path skewing left by rolling elements along raceway surfaces.		<b>Causes</b> <ul style="list-style-type: none"> <li>Shaft or housing of insufficient accuracy.</li> <li>Improper installation.</li> <li>Insufficient shaft or housing rigidity.</li> <li>Shaft whirling caused by excessive internal bearing clearances.</li> </ul>
		<b>Correction</b> <ul style="list-style-type: none"> <li>Reinspect bearing's internal clearances.</li> <li>Review accuracy of shaft and housing finish.</li> <li>Review rigidity of shaft and housing.</li> </ul>
<b>Smearing and scuffing</b> The surface becomes rough and some small deposits form. Scuffing generally refers to roughness on the race collar and the ends of the rollers.		<b>Causes</b> <ul style="list-style-type: none"> <li>Inadequate lubrication.</li> <li>Entrapped foreign particles.</li> <li>Roller skewing due to a misaligned bearing.</li> <li>Bare spots in the collar oil film due to large axial loading.</li> <li>Surface roughness.</li> <li>Excessive slippage of the rolling elements.</li> </ul>
		<b>Correction</b> <ul style="list-style-type: none"> <li>Reevaluation of the lubricant type and lubrication method.</li> <li>Bolster sealing performance.</li> <li>Review preload.</li> <li>Review service conditions.</li> <li>Improve assembly method and handling</li> </ul>
<b>Rust and corrosion</b> The surface becomes either partially or fully rusted, and occasionally rust even occurs along the rolling element pitch lines.		<b>Causes</b> <ul style="list-style-type: none"> <li>Poor storage conditions.</li> <li>Poor packaging.</li> <li>Insufficient rust inhibitor.</li> <li>Penetration by water, acid, etc.</li> <li>Handling with bare hands.</li> </ul>
		<b>Correction</b> <ul style="list-style-type: none"> <li>Take measures to prevent rusting while in storage.</li> <li>Periodically inspect the lubricating oil.</li> <li>Improve sealing performance.</li> <li>Improve assembly method and handling.</li> </ul>

**Table 16.1 Bearing damage, main causes of bearing damage and remedies for correcting the problem**

Description		
<b>Fretting</b>	There are two types of fretting. In one, a rusty wear powder forms on the mating surfaces. In the other, brinelling indentations form on the raceway at the rolling element pitch.	<div data-bbox="1019 369 1367 548"> <p><b>Causes</b></p> <ul style="list-style-type: none"> <li>• Insufficient interference.</li> <li>• Small bearing oscillation angle.</li> <li>• Insufficient lubrication.(unlubricated)</li> <li>• Fluctuating loads.</li> <li>• Vibration during transport, vibration while stopped.</li> </ul> </div> <hr/> <div data-bbox="1019 548 1367 726"> <p><b>Correction</b></p> <ul style="list-style-type: none"> <li>• Select a different kind of bearing.</li> <li>• Select a different type of lubricant.</li> <li>• Review the interference and apply a coat of lubricant to fitting surface.</li> <li>• Pack the inner and outer rings separately for transport.</li> </ul> </div>
<b>Wear</b>	The surfaces wear and dimensional deformation results. Wear is often accompanied by roughness and scratches.	<div data-bbox="1019 726 1367 905"> <p><b>Causes</b></p> <ul style="list-style-type: none"> <li>• Entrapment of foreign particles in the lubricant.</li> <li>• Inadequate lubrication.</li> <li>• Skewed rollers.</li> </ul> </div> <hr/> <div data-bbox="1019 905 1367 1083"> <p><b>Correction</b></p> <ul style="list-style-type: none"> <li>• Review lubricant type and lubrication methods.</li> <li>• Improve sealing performance.</li> <li>• Take steps to prevent misalignment.</li> </ul> </div>
<b>Electrolytic corrosion</b>	Pits form on the raceway. The pits gradually grow into ripples.	<div data-bbox="1019 1083 1367 1262"> <p><b>Causes</b></p> <ul style="list-style-type: none"> <li>• Electric current flowing through the rollers.</li> </ul> </div> <hr/> <div data-bbox="1019 1262 1367 1440"> <p><b>Correction</b></p> <ul style="list-style-type: none"> <li>• Create a bypass circuit for the current.</li> <li>• Insulate the bearing.</li> </ul> </div>
<b>Dents and scratches</b>	Scoring during assembly, gouges due to hard foreign objects, and surface denting due to mechanical shock.	<div data-bbox="1019 1440 1367 1619"> <p><b>Causes</b></p> <ul style="list-style-type: none"> <li>• Entrapment of foreign objects.</li> <li>• Bite-in on the flaked-off side.</li> <li>• Dropping or other mechanical shocks due to careless handling.</li> <li>• Assembled misaligned.</li> </ul> </div> <hr/> <div data-bbox="1019 1619 1367 1795"> <p><b>Correction</b></p> <ul style="list-style-type: none"> <li>• Improve handling and assembly methods.</li> <li>• Bolster sealing performance. (measures for preventing foreign matter from getting in)</li> <li>• Check area surrounding bearing. (when caused by metal fragments)</li> </ul> </div>

**Table 16.1 Bearing damage, main causes of bearing damage and remedies for correcting the problem**

Description		
<p><b>Creeping</b></p> <p>Surface becomes mirrored by sliding of inside and outside diameter surfaces. May be accompanied by discoloration or score.</p> <div style="display: flex; justify-content: space-around;">   </div>	<p><b>Causes</b></p> <ul style="list-style-type: none"> <li>• Insufficient interference in the mating section.</li> <li>• Sleeve not fastened down properly.</li> <li>• Abnormal temperature rise.</li> <li>• Excessive loads.</li> </ul> <p><b>Correction</b></p> <ul style="list-style-type: none"> <li>• Reevaluate the interference.</li> <li>• Reevaluate usage conditions.</li> <li>• Review the precision of the shaft and housing.</li> <li>• Raceway end panel scuffing</li> </ul>	
<p><b>Speckles and discoloration</b></p> <p>Luster of raceway surfaces is gone; surface is matted, rough, and / or evenly dimpled. Surface covered with minute dents.</p> <div style="display: flex; justify-content: space-around;">   </div>	<p><b>Causes</b></p> <ul style="list-style-type: none"> <li>• Infiltration of bearing by foreign matter.</li> <li>• Insufficient lubrication.</li> </ul> <p><b>Correction</b></p> <ul style="list-style-type: none"> <li>• Reevaluation of lubricant type and lubrication method.</li> <li>• Review sealing mechanisms.</li> <li>• Examine lubrication oil purity. (filter may be excessively dirty, etc.)</li> </ul>	
<p><b>Peeling</b></p> <p>Patches of minute flaking or peeling (size, approx. 10 μm). Innumerable hair-line cracks visible though not yet peeling. (This type of damage frequently seen on roller bearings.)</p> <div style="display: flex; justify-content: space-around;">  </div>	<p><b>Causes</b></p> <ul style="list-style-type: none"> <li>• Infiltration of bearing by foreign matter.</li> <li>• Insufficient lubrication.</li> </ul> <p><b>Correction</b></p> <ul style="list-style-type: none"> <li>• Reevaluation of lubricant type and lubrication method.</li> <li>• Improve sealing performance. (to prevent infiltration of foreign matter)</li> <li>• Take care to operate smoothly.</li> </ul>	

